

EXPERIENCE AN ULTRA LIGHTWEIGHT
WITH SMART CONTROL

MyVet Ray W

WEIGHT INNOVATION



Wall-Mounted Dental X-Ray

- Weight innovation with CNT (Carbon Nanotube) technology
- Smart angulation for optimal result
- Secure clear images with a 0.4 mm focal spot



EFFICIENCY AND FUNCTIONALITY

Acquire clear images with a 0.4 mm focal spot

- Regardless of which intraoral sensor you use, the MyVet Ray W minimizes blur and provides additional diagnostic value with a 0.4mm focal spot.

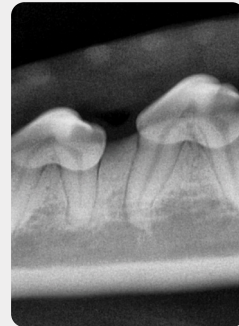
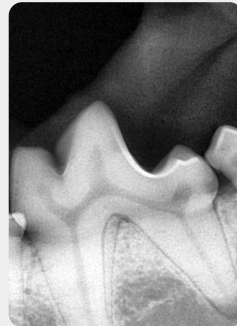
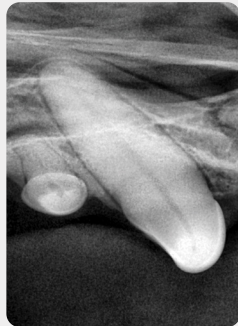

Ergonomic design for safety and easy to use

[Stable Arm]

Perfectly counterbalanced arm ensures stability

[Non-Drifting Arm]

The strong and stable arm allows accurate and stable positioning

[Smooth Joint]

Full range smooth glide for easy positioning

[Round Shape Design]

Contoured Edges – Ergonomic and modern design to secure safety

[Lightweight Tube Head]

The 5.6 lbs lightweight tube head secures high stability

[Intuitive Control Panel]

Easy to set with a dial controller and easy to read control panel

[Ergonomic One-Handed Grip]

The strong hand grip produces a faster workflow

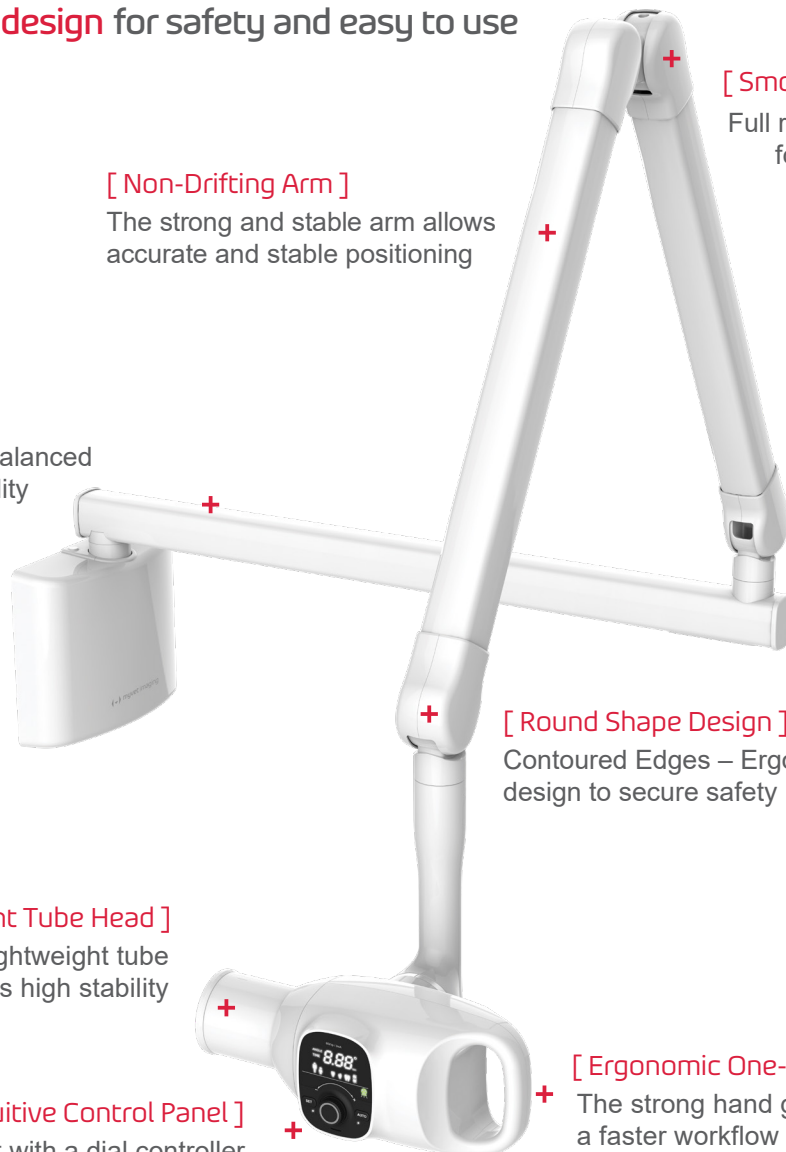

◀ LIGHTWEIGHT with CNT TECHNOLOGY

📺 CNT Tube

- Lower dose to user
- Greater longevity
- Consistent target exposure
- Stable high efficiency energy

CNT technology
Smaller x-ray tube

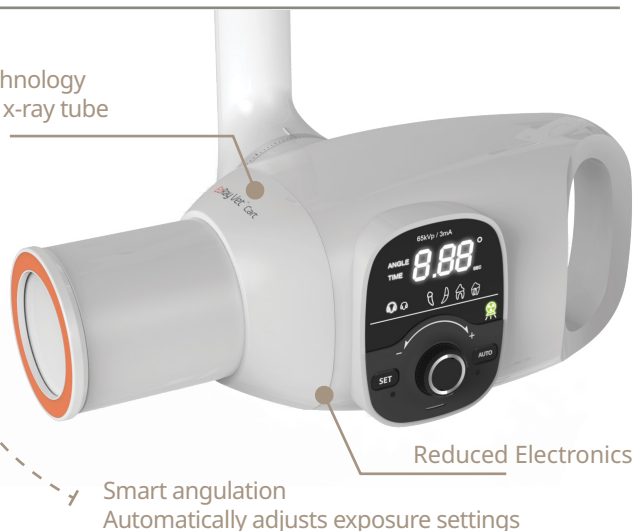

📺 Smart angulations exposure compensation

Acquiring certain areas of the mouth are difficult to image, such as the rostral and caudal maxilla or the rostral mandible, due to one structure superimposed over an area of interest or difficult sensor placement. When parallel imaging techniques cannot be used, the tube head must be angled appropriately to capture these images. X-ray operators often do not change exposure settings and image quality will vary as a result of this angulation. The MyVet Ray W can optimize an image exposure setting based on the angle of the tube head.

Step 1. Set the reference point.

Step 2. Exposure conditions for each tooth are set automatically by the specified angle.

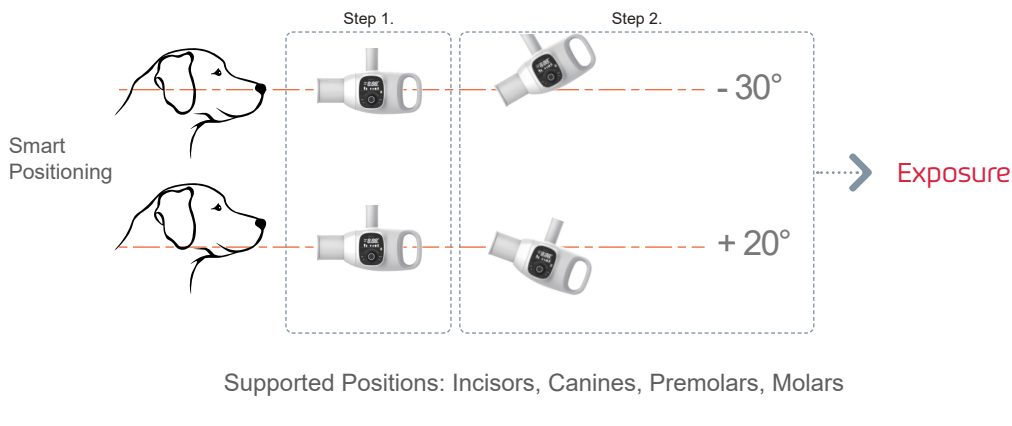

📺 Smart dial for all functions

The operating panel located on the tube head creates a simpler and faster workflow. The Smart Dial has all the setting in one dial, streamlining the workflow and decreasing preparation time. There is no need to remember complicated control panel buttons and configurations.



New generation wall-mounted x-ray with carbon nanotube technology obtains high quality intraoral diagnostic images

SPECIFICATIONS

Focal Spot	0.4 mm (IEC 60336)
Tube Voltage (kV)	65 kV
Current (mA)	3.0 mA
Exposure Time Range	0.05 ~ 0.5 (0.01s increment)
Source to Skin Distance	Min. 7.9 in (200 mm)
X-Ray Field	2.4 in (60 mm) Round
Arm Length (Option of horizontal arm)	450 mm (62"), 600 mm (68"), 900 mm (80") - See note A and B for comparison
Accessories	Remote Exposure Switch
Weight	36 lbs (450 mm), 37 lbs (600 mm), 40 lbs (900mm)

* Specifications are subject to change without prior notice.

DIMENSIONS (Unit: mm)

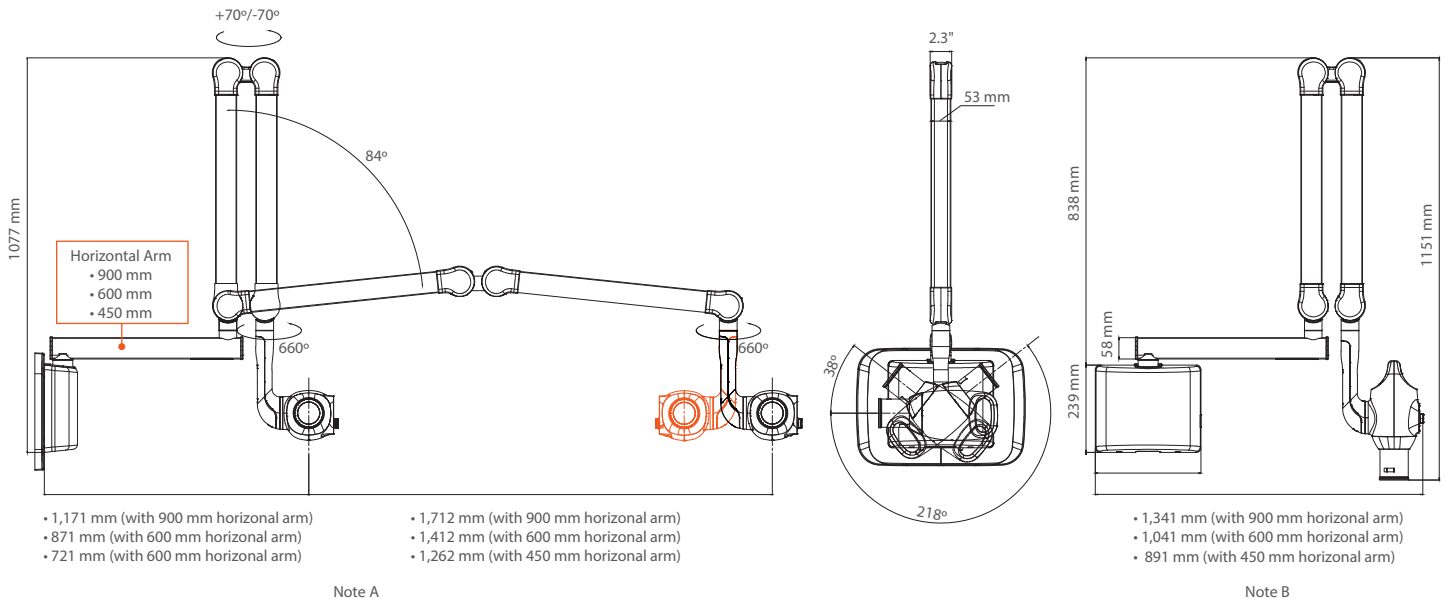

MyVet Ray W



Rayence & MyVet Inc.
 81 Ruckman Rd. Unit A, Closter NJ 07624
 Tel: 201.561.0223
 information@myvetimaging.com www.myvetimaging.com